



THE LEADERS IN RECREATION, FITNESS, AND ABILITY!

9889 Garrymore Ln
Missoula, MT 59808

888-687-3552 | +1-406-549-0769

www.aquacreek.com

Mighty 400 Pool Lift

PART #: F-MTY400-03

US PATENT PENDING: [16/205,638]

US PATENT NUMBER: [D507,769 S]

400 LB. [181 kg] MAXIMUM WEIGHT CAPACITY

FOR INDOOR OR OUTDOOR USE

MANDATORY

LEAVE THIS MANUAL WITH LIFT OWNER

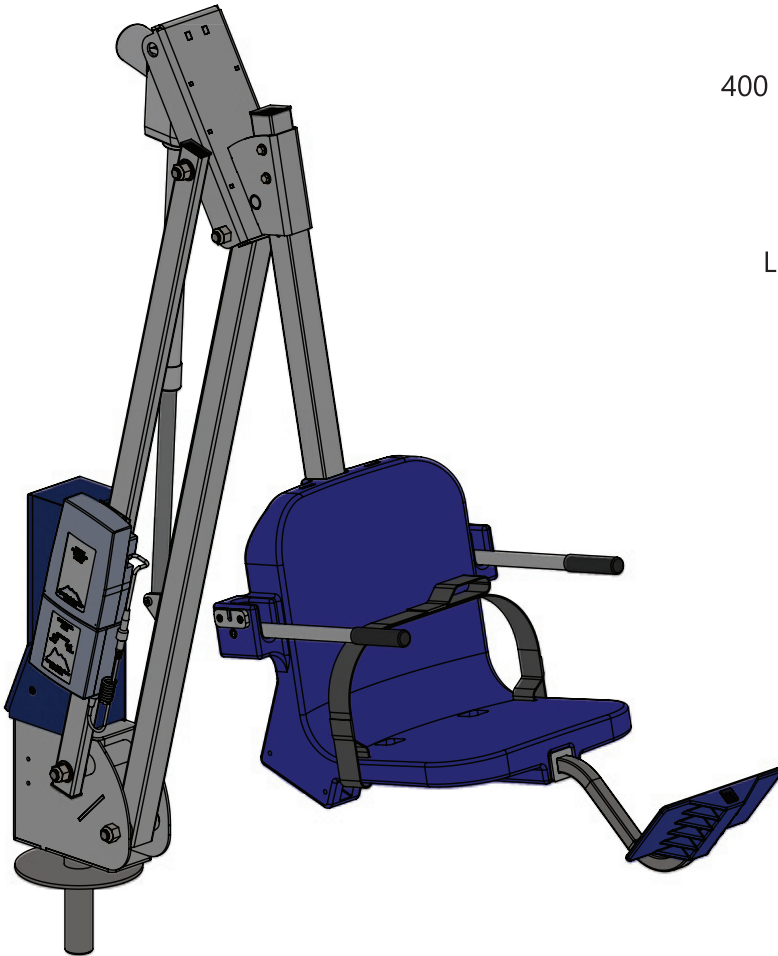

READ CAREFULLY

Check entire box and inside all packing materials for parts. Before beginning assembly, read the instructions and identify parts using the figures and parts listed in this document.

It is critical all parts be carefully inspected by the installer prior to installation to ensure no damage occurred in transit and a damaged part is not used. If any damage occurred in transit, Aqua Creek Products, LLC must be notified within three days of receipt of unit.

Proper installation cannot be overstressed, as an improper installation voids Aqua Creek's warranty and may affect the safety of the user.

Mighty 400 Lift

IMPORTANT SAFETY INSTRUCTIONS



When installing and using this electrical appliance, basic precautions should always be followed, including the following:

READ ALL INSTRUCTIONS BEFORE USING

WARNING - To reduce the risk of injury, do not permit children to use this product unless they are closely supervised at all times.

This appliance is not intended for use by persons (including children) with reduced physical, sensory or mental capabilities, or lack of experience and knowledge, unless they have been given supervision or instruction concerning use of the appliance by a person responsible for their safety.

A wire connector is provided on the unit to connect a minimum 8 AWG (8.4mm²) solid copper conductor between this unit and the means for local equipotential bonding.

Check the unit periodically for signs of deterioration: Keep all nuts, bolts and screws tight to be sure the lift is in safe working condition.

SAVE THESE INSTRUCTIONS

Affix supplied ADA POOL/SPA LIFT sign in a location visible from the lift at all times.

Rechargeable batteries are to be removed from the appliance before being charged. Batteries are to be inserted with the correct polarity. If the appliance is to be stored unused for a long period of time, the batteries should be removed. The supply terminals are not to be short-circuited.

REDUCE THE RISK OF DROWNING!

Supervise children at all times.

No jumping or diving from the lift.

Seat may be hot, use caution when entering.

Keep covered when not in use. Inspect and clean before use.

INDOOR BATTERY CHARGER:

AMPERAGE = 0.65 FREQUENCY = 60

24 VOLT BATTERY

AMPERAGE = 8 IP RATING = IPX5

Mighty 400 Lift

Table of Contents

PAGE	DESCRIPTION	PAGE	DESCRIPTION
3	Mighty 400 Components	10	Basic Troubleshooting
4	ADA Installation Guidelines	11	Battery Test Cable Instructions
5-6	Anchor Installation: Core-Drill Retro-Fit	12	Pinch Point Locations
7	Anchor Installation: Saw-Cut Retro-Fit/ New Construction	13	Proper Care of Pool & Spa Lifts
8	Mighty 400 Lift Assembly Instructions	14	Mighty 400 Parts List
9	Footrest Installation Instructions	15	Warranty

Mighty 400 Components

1. BASE AND MOTOR ASSEMBLY
2. CONTROL ARMS
3. LIFTING ARM
4. ADJUSTABLE SEAT ARM
5. TOP CASING ASSEMBLY
6. FOOTREST
7. LINAK ACTUATOR
8. VITO 24 V BATTERY
9. HANDSET
10. HARDWARE BAG

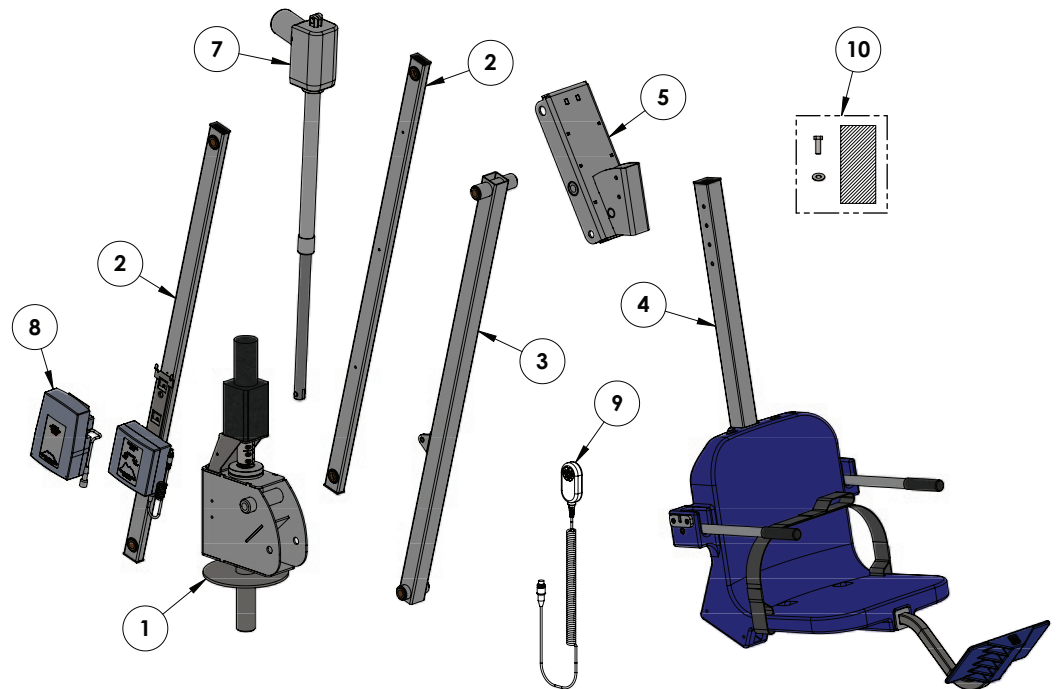

Installation: ADA Guidelines

ADA REQUIREMENTS (For Commercial Applications):

The Mighty 400 lift is completely ADA compliant when installed correctly.

The installation must meet the following requirements:

- Clear deck space dimensions (see FIGURE 1)
- Install lift a minimum of 24 inches from the pool edge
(For curved pool walls contact Aqua Creek for placement)
- Deck slope no greater than 1:48
- The seat must be submerged at least 18 inches into the water. The lift should be installed at a location with 42-48 inches of depth (deck to pool floor)

NOTE: Other requirements may be necessary based on local code requirements. The anchor system should be bonded according to NEC Section 680 and/or local code requirements.

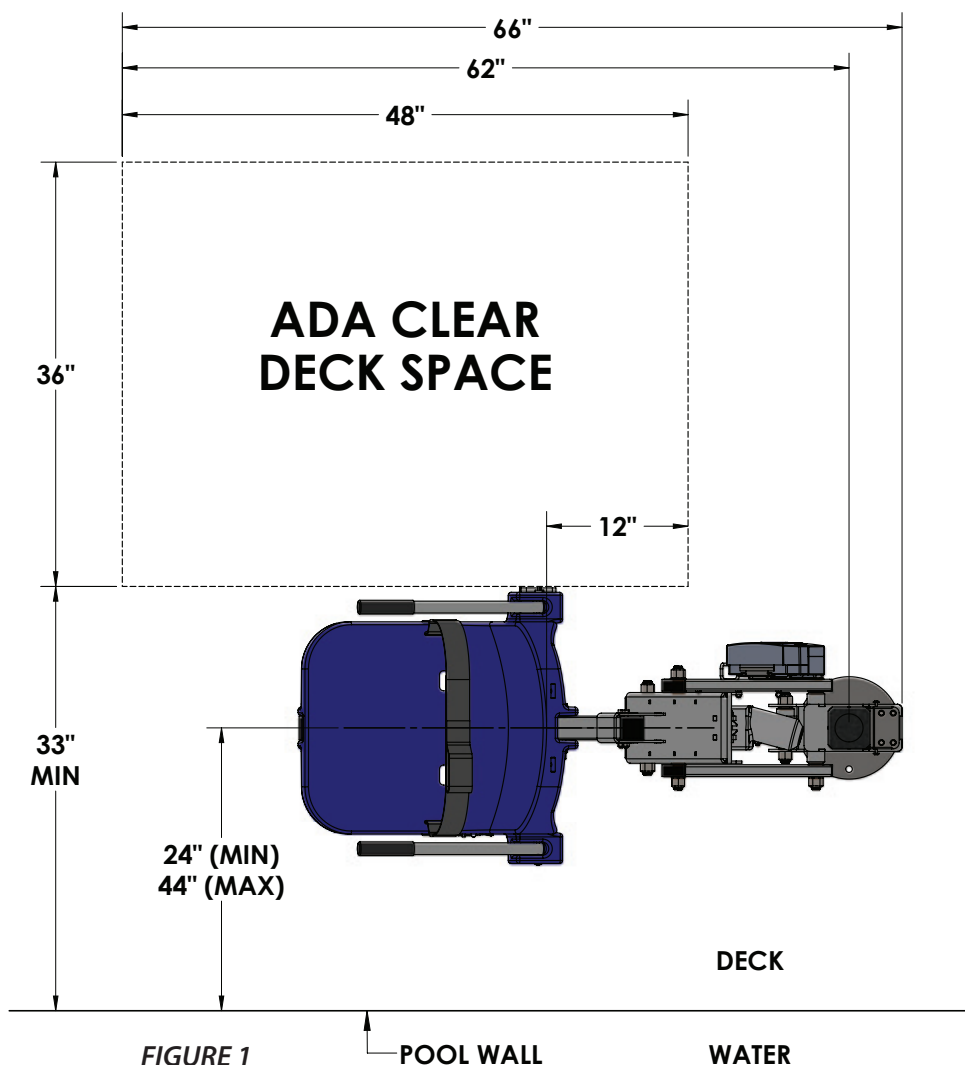

Anchor Installation: Core-drill Retro-fit (Typical Concrete Pool Deck Installation)

Your deck MUST have:

- Minimum footing size: 4' - 0" x 4' - 0" x 10" thick.
- Minimum concrete strength: 2500 psi
- Reinforcement: #5 rebar @ 10" on center (O.C.)

TOOLS REQUIRED:

CORE DRILL	MARKING PEN
3" CORE DRILL BIT	AIR NOZZLE & PUMP/COMP.
1 1/2" CORE DRILL BIT	HEAT GUN (OPTIONAL)
EPOXY (ANCHOR ADHESIVE)*	MASKING TAPE

*Use HILTI RE-500-SD adhesive anchor or SIMPSON SET-XP anchor adhesive or equivalent.

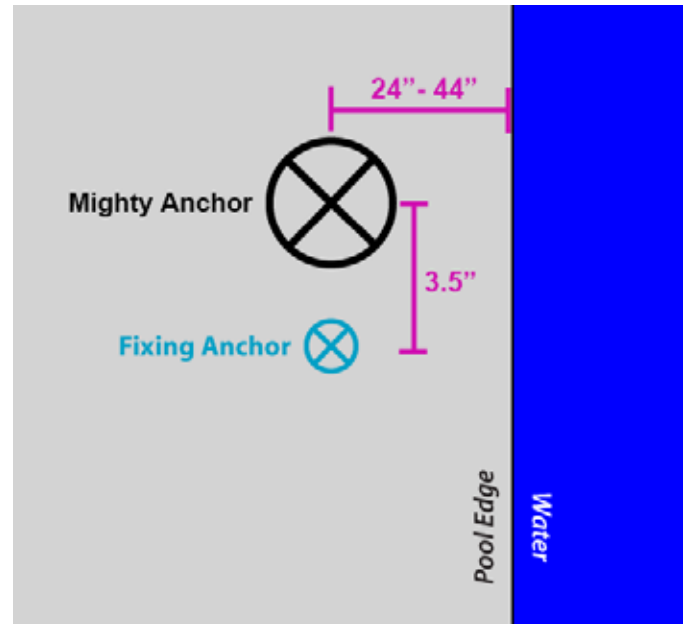

NOTE: Your local codes may require one or more permits. Check with your local building codes for the proper permit requirements.

1. Mark the center of the anchor location on your deck using the guidelines on page 4. Also mark the center for the fixing anchor 3 1/2" from the center anchor.
2. Using a 3" diameter core-drill bit, drill a 3" diameter hole at the anchor location. Make sure to keep the bit square to the deck. Drill straight down to a depth of at least 6". Then use a 1 1/2" drill bit for the fixing anchor, drilling down at least 4"

NOTE: Create a depth marker on the drill bit with black electrical tape to make sure you drill to the right depth.
If you drill through the deck you may need to use the saw-cut installation instructions.

3. Remove plug and clean out the holes with a wire brush. Insert an air nozzle to the bottom of the hole. Use a pump or compressed air to blow out the hole. A heat-gun may be helpful in drying out the hole.

continued on page 6

Anchor Installation: Core-drill Retro-fit (CONTINUED)

4. Place the anchor in the hole and 'dry-fit' it first to make sure the anchor will be flush and plumb with the finished deck surface when installed. Adjust the hole as needed.

NOTE: Pool decks with pavers or thick tiles may require other anchor options. Contact Aqua Creek Products.

5. Inject epoxy adhesive into each hole starting at the bottom until the hole is 1/3 to 1/2 full.

NOTE: We recommend using masking tape around the top of the anchors so that no epoxy gets inside the anchors.

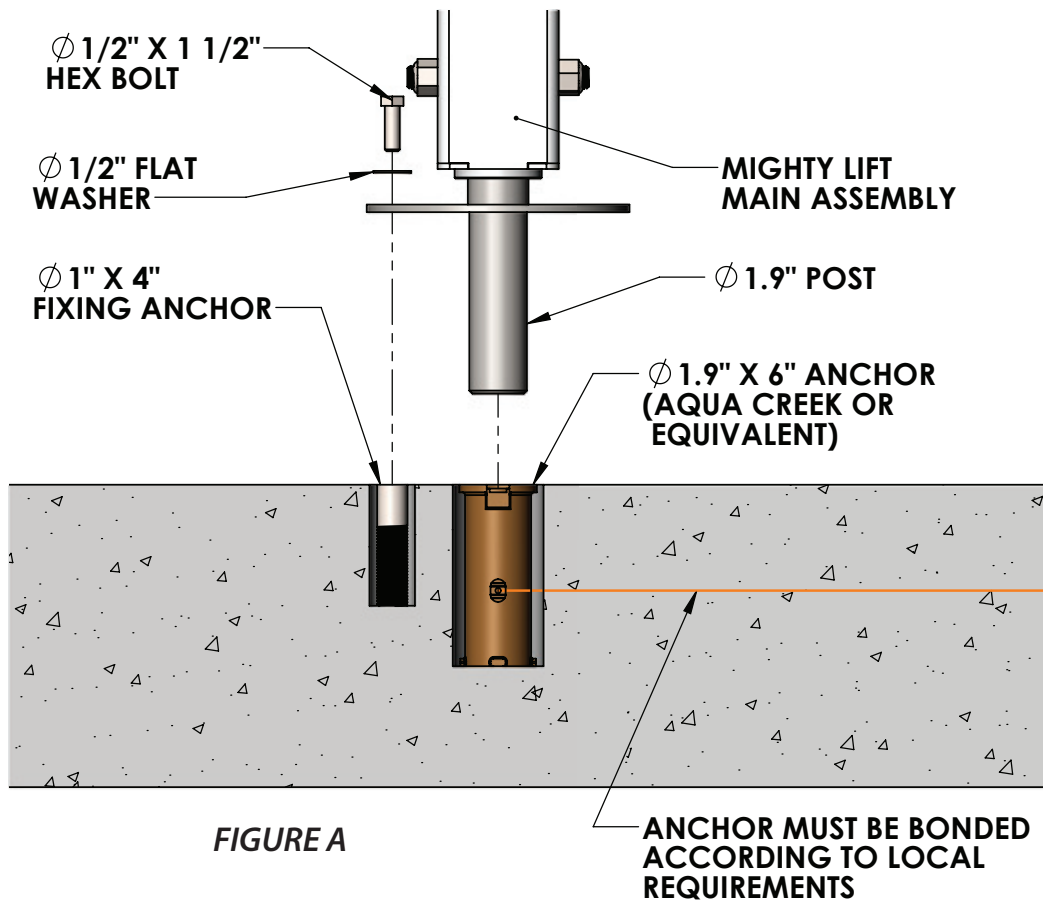

6. Install the anchor into the epoxy filled hole by pushing down and twisting back and forth to evenly distribute the epoxy around the anchor. Push down until it is flush with the finished deck surface. Clean off any excess epoxy. Adjust the anchor as needed to make sure it is flush and plumb with the deck surface. This should be done during the adhesives' specified 'gel time' (see epoxy manufacturers' instructions).

7. Let the epoxy cure for at least 24 hours before installing the lift (or where applicable according to the epoxy manufacturers' instructions).

Anchor Installation: Saw-cut Retro-fit/New construction

1. Mask the bottom hole of the anchor sleeve to prevent concrete from seeping in.
2. Install rebar in the 4'-0" x 4'-0" section of the deck that will be thickened to 10". SEE FIGURES B & C.
3. Set the bronze anchor sleeve in place. Make sure the center of the anchor sleeve is no more than 44" from the pool's edge. Set the fixing anchor insert 3 1/2" from the center of the anchor sleeve. Fixing anchor may be located anywhere on the deck, as long as it is 3 1/2" from the center of the anchor sleeve. SEE FIGURE B.
4. Bond the anchor sleeve according to your local code requirements by using the bonding lug and bonding screw on the side of the anchor sleeve.
5. Pour your concrete and finish the pool deck surface.
6. Once the concrete has cured, your lift is ready to be mounted into the anchor sleeve.

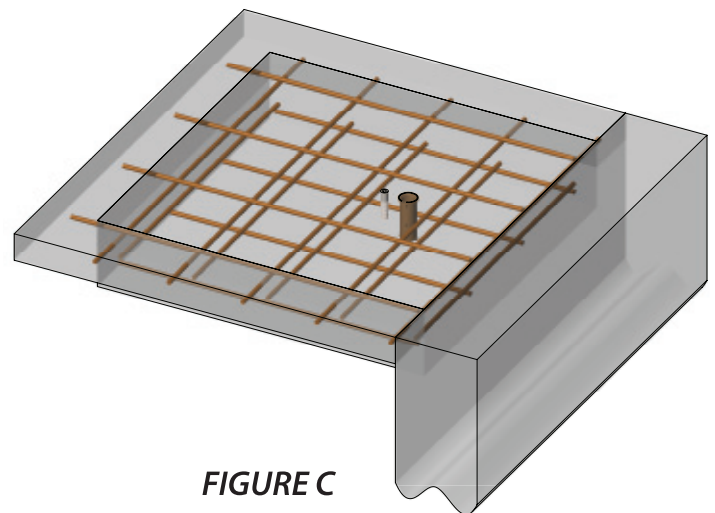
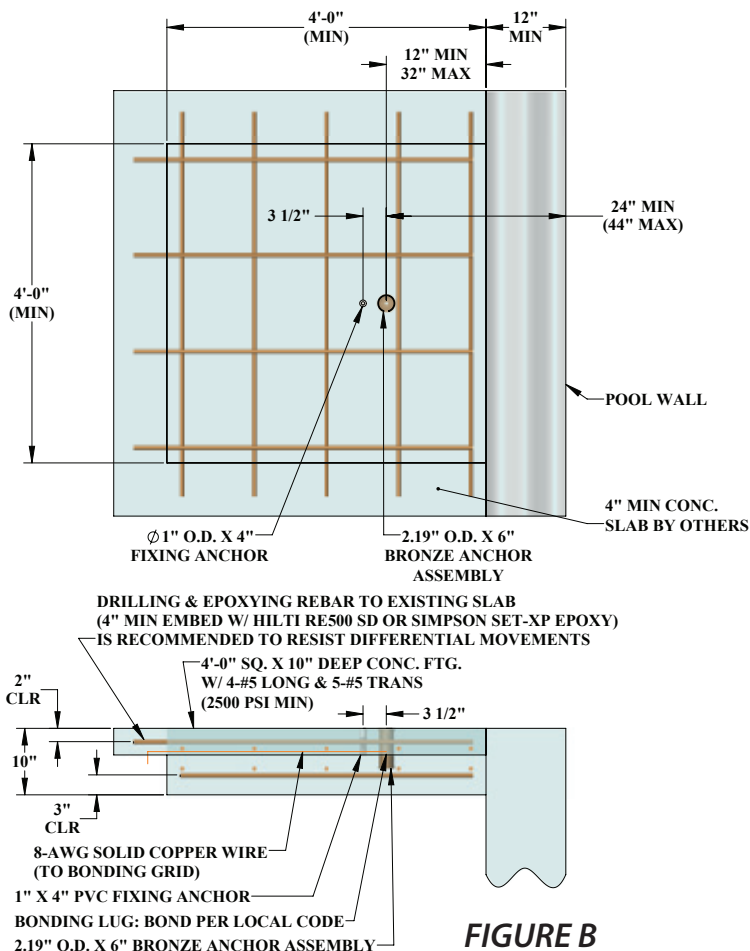

Mighty 400 Assembly Instructions

TOOLS REQUIRED:
1/2" WRENCH (2)

WARNING: NEVER LIFT THE MAIN ASSEMBLY USING THE LINEAR ACTUATOR AS A HANDLE! USE AT LEAST TWO PEOPLE TO LIFT.

- 1.** Lift the Mighty 400 MAIN ASSEMBLY from the shipping container. Insert the 1.9" [48mm] post of the MAIN ASSEMBLY into the deck anchor (FIGURE A, PAGE 6). Ease the MAIN ASSEMBLY down until it rests on the deck surface. Rotate the base until the fixing anchor hole lines up with the fixing anchor. Install the 1/2" x 1 1/2" hex bolt and washer to hold down the lift. Tighten the bolt.
- 2.** Remove all of the shipping materials from the lift. Slide the CHAIR AND CHAIR ARM ASSEMBLY up through the top casing of the MAIN ASSEMBLY and connect using the supplied 5/16" hex bolts, washers and nylock nuts. For standard pool configuration the CHAIR ARM will be connected at the top two holes. However, the chair arm can be adjusted up to 6 inches higher, in 2 inch increments, if there is a need for it. **NEVER USE THE LIFT WITHOUT BOTH HEX BOLTS INSTALLED!**

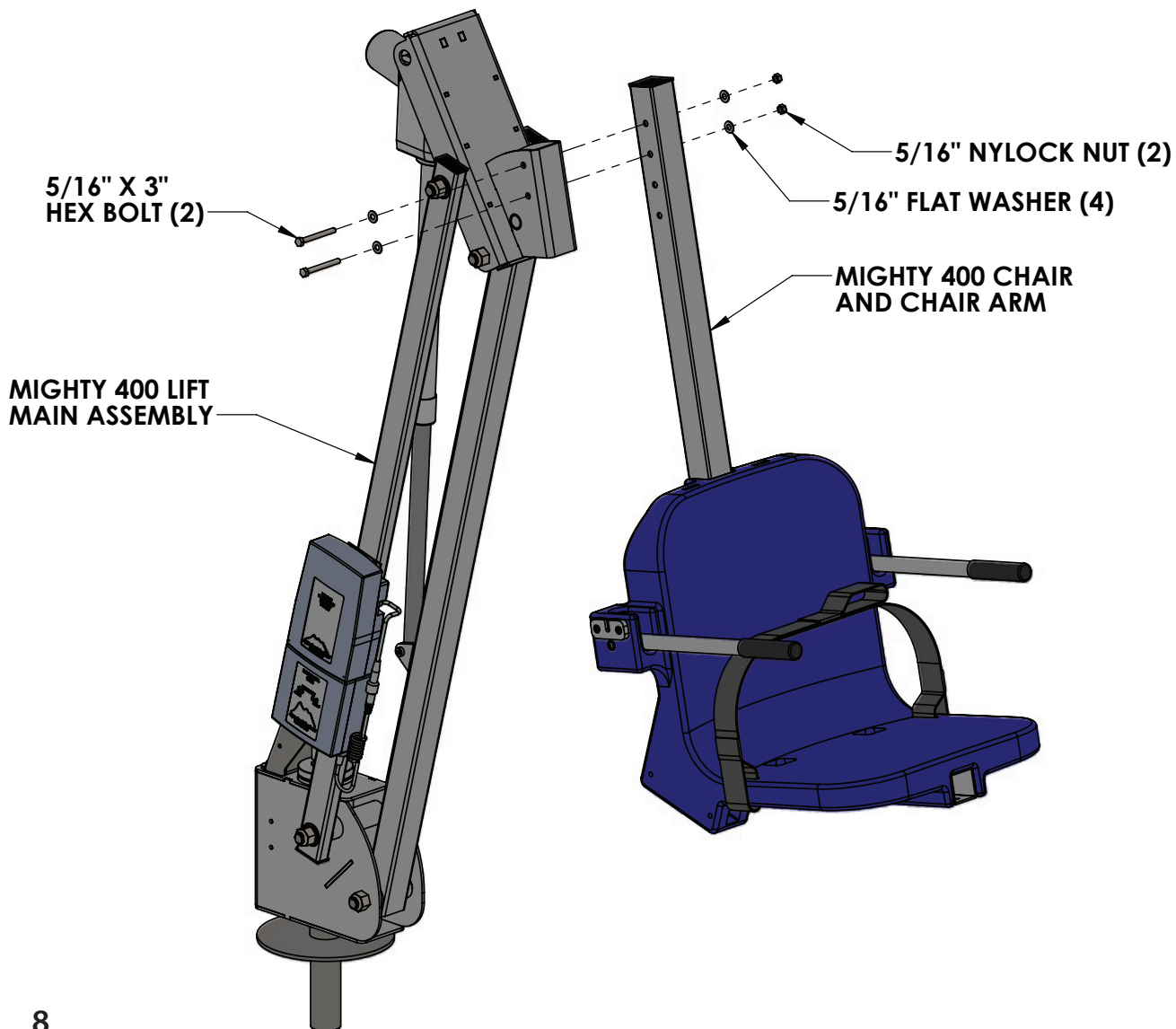

Footrest Installation Instructions

The Aqua Creek footrest assembly is designed to fit under the chair and is installed inside the 2" square tubing that supports the chair from underneath. To install the footrest;

1. Insert the footrest assembly into the 2 x 2 square tubing that supports the chair until the plastic insert of the footrest assembly sits flush against the end of the 2 x 2 tube.
2. Using the supplied 1/4" hardware, fasten the legrest assembly to the 2 x 2 tubing.

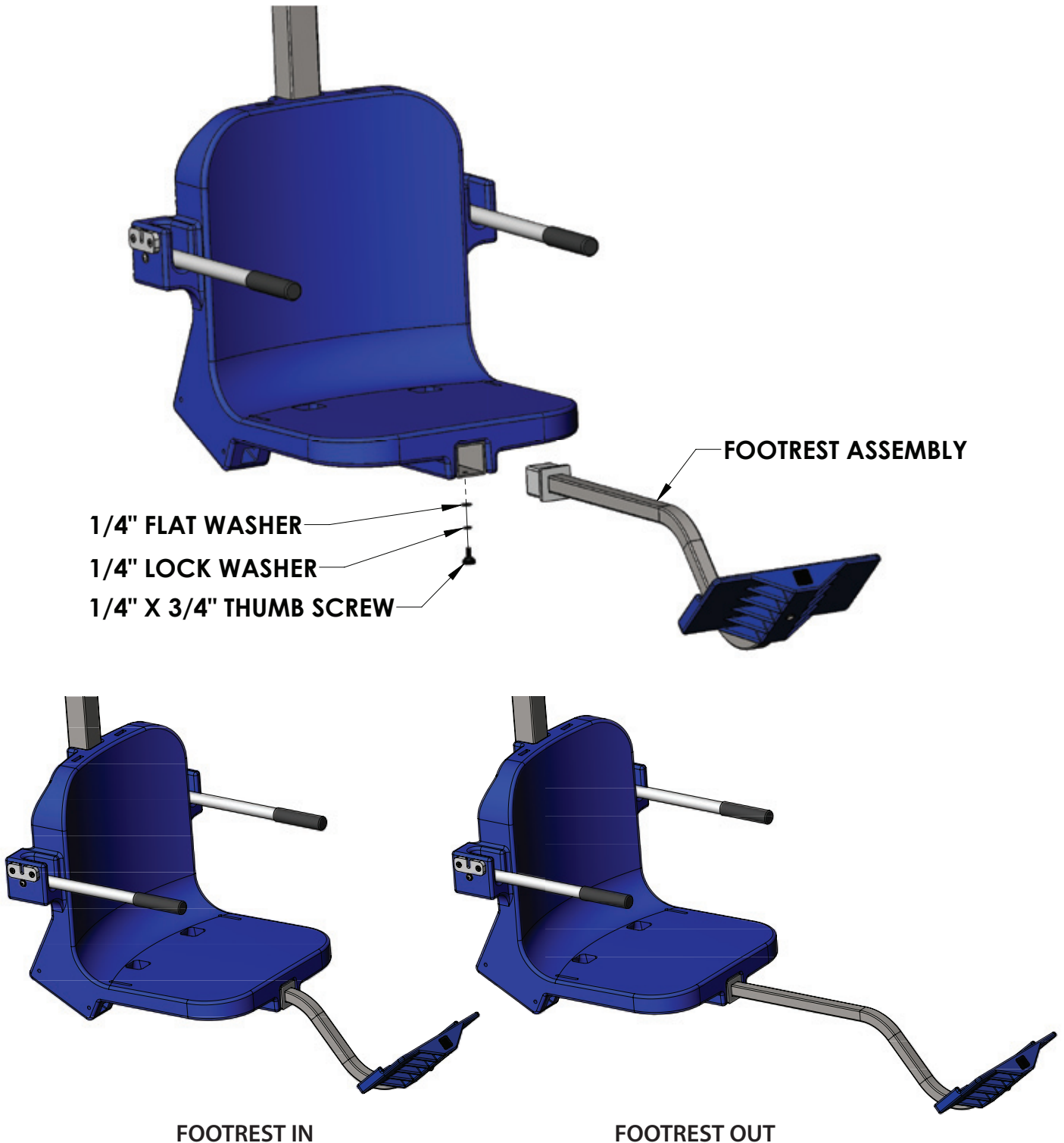

Basic Troubleshooting

Problem: The lift won't move.

Solution:

1. Make sure the cords are properly plugged in:



NOT Properly Inserted:
The cord plug is flush with or sticking out of the outlet



Properly Inserted:
The cord plug is recessed into the outlet

Check the ends of the cords for corrosion or damage. The cord plugs should be recessed into the outlet. You should feel them pop into place when they are correctly inserted.

2. Check the contact points:



Make sure the contact point of the control box and the battery are not damaged or corroded. If there is corrosion clean with Scotch-Brite™ pad. Put some dielectric grease on the contact points before reattaching the battery.

3. Make sure the battery is fully charged:



The Charger is ON when the green light is glowing

The Battery is CHARGING when the orange light is glowing

When the Battery is fully charged the orange light will stop glowing

Problem: The lift stopped moving and is stuck.

Solution:

1. Press the Emergency button

Press the emergency retract button on the front of the control box to retract the lift.

Note: the lift will not retract if the battery is not fully charged or if the control box is not working. The emergency button only overrides the remote handset.



For troubleshooting videos Visit: www.aquacreek.com or scan the QR code below using your smartphone.

FOR TROUBLESHOOTING ASSISTANCE



Note: If you feel your lift is malfunctioning due to a faulty battery or connections, contact Aqua Creek Products for a testing kit.

Battery Test Cable Instructions

WARNING! DO NOT ATTEMPT TO DIRECTLY PROBE THE BATTERY CONNECTOR TO TEST VOLTAGE. THIS MAY CAUSE PERMANENT DAMAGE TO THE BATTERY! USE THE SUPPLIED BATTERY TEST CABLE ONLY FOR CHECKING THE BATTERY VOLTAGE!

The Aqua Creek 24V battery has a cable and connector for connecting to the control box or to the battery charger. The battery connector is not suitable to check the battery voltage, as it is very hard to probe the connector without shorting-out the battery, which will cause damage. For this reason, a separate battery test cable is provided. To safely check the battery voltage, use a voltmeter or multi-meter with standard test probes, and insert the probes into the test cable as shown below.

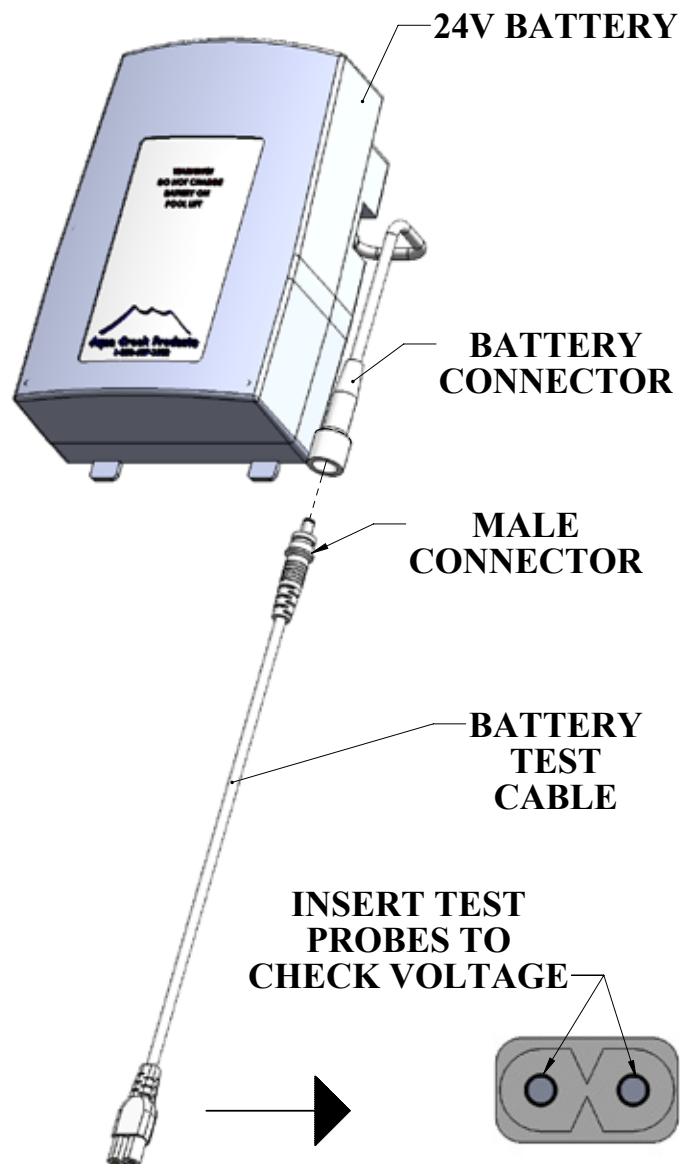

Pinch Point Locations

**CAUTION!
PINCH POINT AREA!
LIFT TO BE STICKERED
ON EACH ARM!**



**CAUTION!
PINCH POINT AREA!
LIFT TO BE STICKERED
ON INSIDE FACE OF ARM!**

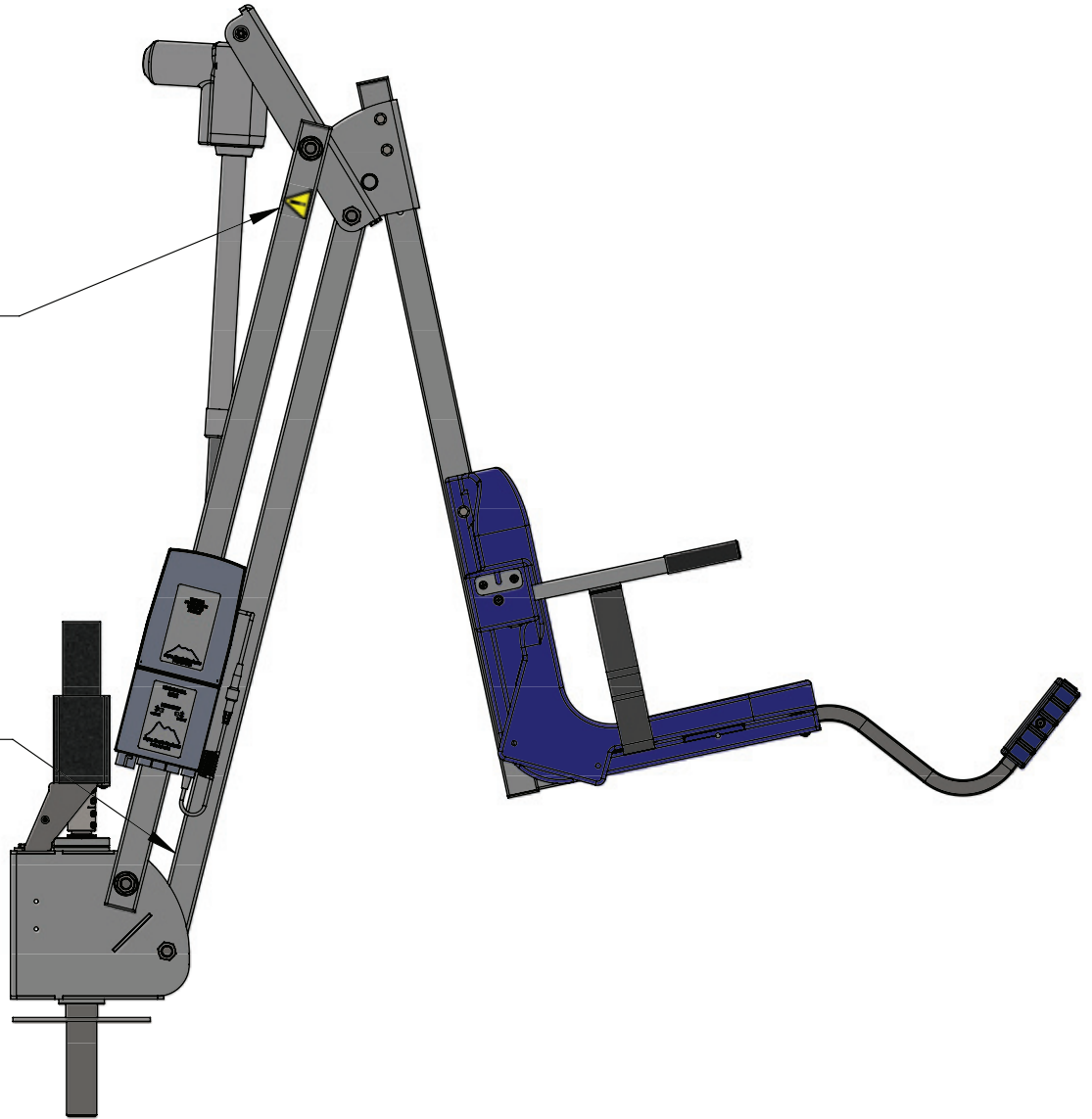

Proper Care of Pool & Spa Lifts

PROCEDURE	BEFORE EACH USE	DAILY	WEEKLY	MONTHLY
Check battery level indicator on control box	✓			
Run the lift through a complete test cycle (fully extend actuator) to verify it is functioning properly	✓			
Wash lift with fresh water and dry with clean, soft, non-abrasive cloth		✓		
Recharge battery		✓		
Visually inspect lift for damage, corrosion, and loose or missing hardware		✓		
Check all contact points for damage and/or corrosion			✓	
Repair, clean, and apply dielectric grease to all contact points			✓	
Thoroughly clean lift frame and apply a liberal coat of car wax to maintain the lift's finish				✓
Check all warning and cautionary labels to make sure they are not faded or worn. Replace as needed.				✓

PROPER CARE NOTES

- **Use only fresh water to wash your lift. Do not wash with pool water.**
- Use only clean, soft, non-abrasive cloths on your lift.
- Do not store lift in pump room or near chemicals.
- Do not allow children to play on or around this lift.
- When cleaning the lift do not spray water directly on control box or battery.
- The lift may need to be bonded according to local code requirements.

STAIN REMOVAL TIPS:

To remove stubborn stains from finish, spray affected area with mild dish soap, rub briskly with a 3M Scotch Brite™ pad. Use white epoxy paint to touch up the finish. Apply wax to protect when dry.

For service and/or replacement parts, contact Aqua Creek Products
Toll free: (888) 687-3552

Mighty 400 Parts List

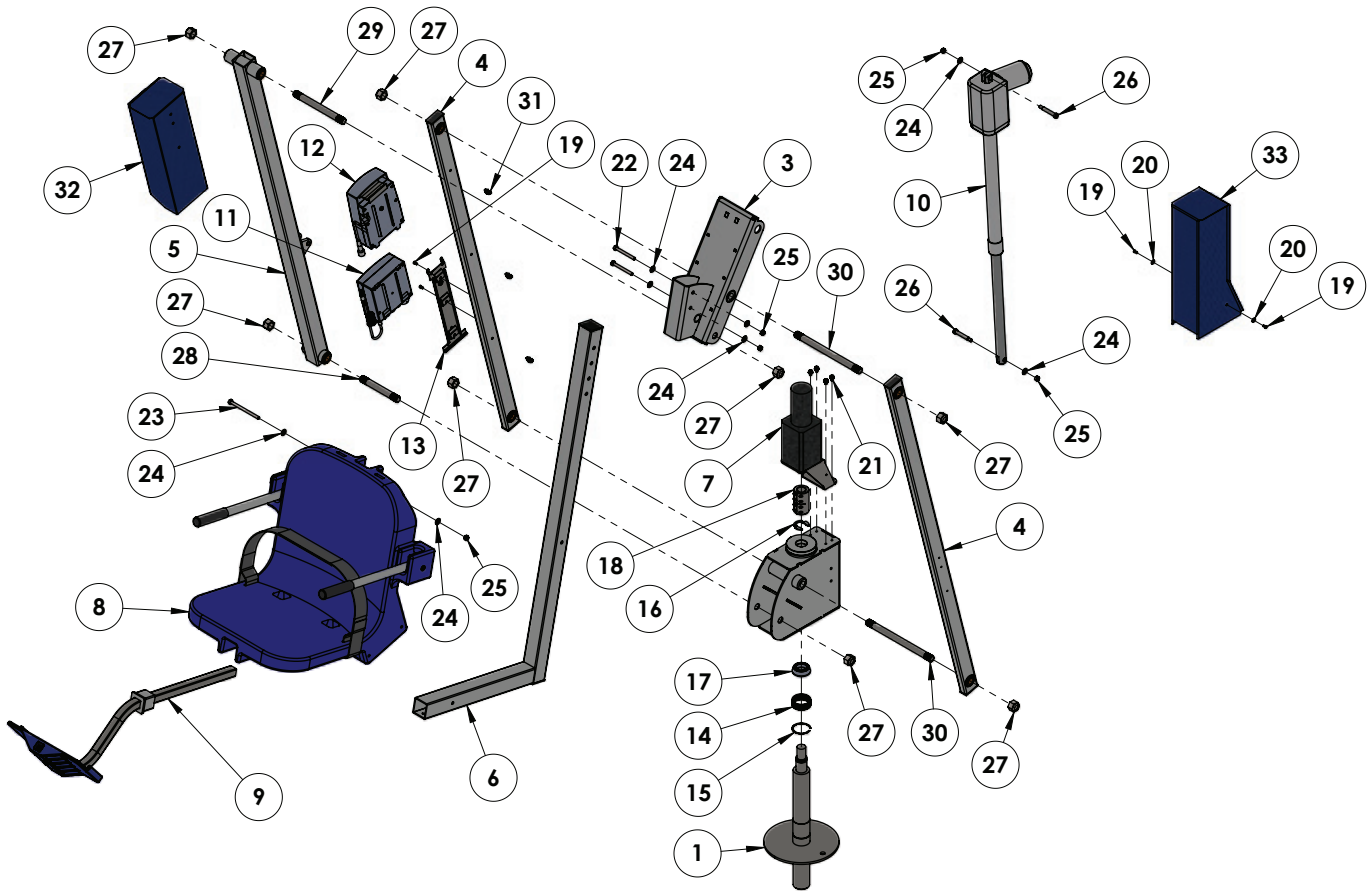

ITEM #	QTY	PART #	DESCRIPTION
1	1	MTY-100WM-00	ANCHOR SPINDLE WELDMENT
2	1	MTY-200WM-00	MAIN FRAME WELDMENT
3	1	MTY-300-00	TOP CASING ASSEMBLY
4	2	MTY-400-00	CONTROL ARM ASSEMBLY
5	1	MTY-500-00	LIFTING ARM ASSEMBLY
6	1	MTY-700-00	CHAIR CRADLE ASSEMBLY
7	1	MTY-900-00	MIGHTY MOTOR ASSEMBLY
8	1	F-0904CA-A	18" CHAIR ASSEMBLY
9	1	F-FRB-03	FOOTREST ASSEMBLY
10	1	341155-02	ACTUATOR, LINAK, 400MM
11	1	VCB10	VITO CONTROL BOX
12	1	VCP100-29800	VITO 24V BATTERY
13	1	GT10 (CONTROL BRACKET)	VITO MOUNTING BRACKET
14	1	K50X55X20H	NEEDLE ROLLER BEARING
15	1	93576A250	SPIRAL EXTERNAL RETAINING RING
16	1	94751A785	EXTERNAL RETAINING RING

ITEM #	QTY	PART #	DESCRIPTION
17	1	BEARING, ROLLER LM67048	ROLLER BEARING & RACE
18	1	INV01703	1" CLAMP ON SHAFT COLLAR
19	4	BSH 10 X 3/8	#10 X 3/8 SOCKET HEAD
20	2	WF 10	#10 FLAT WASHER
21	4	BHW 1/4 X 3/8	1/4-20 X 3/8 HEX WASHER BOLT
22	2	BH 5/16 X 3	5/16-18 X 3 HEX BOLT
23	1	BH 5/16 X 4 1/2	5/16-18 X 4 1/2 HEX BOLT
24	8	WF 5/16	5/16 FLAT WASHER
25	5	NN 5/16	5/16-18 NYLOCK NUT
26	2	BS 3/8 X 2 18-8	3/8 X 2 SHOULDER BOLT
27	8	NN 3/4	3/4-10 NYLOCK NUT
28	1	TS 3/4 X 6	3/4-10 X 6 THREADED STUD
29	1	TS 3/4 X 8	3/4-10 X 8 THREADED STUD
30	2	TS 3/4 X 10 1/2	3/4-10 X 10 1/2 THREAD STUD
31	3	14530	3/8 DIAMETER ROUTING CLIP
32	1	F-UBC	UNIVERSAL BATTERY COVER
33	1	F-MTMC	MIGHTY MOTOR COVER

AQUA CREEK PRODUCTS, LLC LIMITED FIVE (5) YEAR WARRANTY:
MIGHTY LIFT SERIES
(ITEM #'s F-MTY400 & F-MTY600)

Aqua Creek Products, LLC (a.k.a. Aqua Creek) warrants to the original end user purchaser that products manufactured by Aqua Creek, when properly installed in accordance with assembly and installation instructions, and properly used and maintained, shall be free from defects in material and workmanship for a period of **five (5) years from the date of original purchase**, provided that Aqua Creek receives prompt notice in writing of any defect or failure and satisfactory proof thereof, with the following exception(s):

Exceptions:

- All electrical components, including the linear actuator shall have the following warranty period:
 - Year 1-2: 100% Coverage
 - Year 3: 60% Coverage (Customer is responsible for 40% of replacement cost)
 - Year 4: 50% Coverage (Customer is responsible for 50% of replacement cost)
 - Year 5: 40% Coverage (Customer is responsible for 60% of replacement cost)
- Hydraulic actuators and mesh slings shall have a warranty period of **one (1) year from the date of original purchase**.
- Powder coat finish scratches, scrapes, corrosion, or dents from customers normal use, negligence, or abuse

This warranty specifically excludes reimbursement for labor to remove, repair, or install the product and any shipping charges. These warranties do not cover any damages due to accident, force majeure, act of nature, misuse, abuse, negligence or failure to properly maintain any products, or normal wear and tear from day to day operations. In the event that any products are altered, repaired, or improperly installed or improperly used by anyone without the prior written approval by Aqua Creek, all warranties are void. **IMPORTANT: AMOUNT OF WEIGHT PLACED ON LIFT SHALL NOT EXCEED THE RATED LIFTING CAPACITY FOR THE LIFT. NEVER OPERATE THE LIFT UNDER LOAD IN A DRY POOL (WITH NO WATER IN THE POOL).** It is the responsibility of the lift owner to verify the weight of the patron for warranty claim purposes and to ensure that the lift is not overloaded. Non-payment for product to Aqua Creek may void warranty.

To initiate a warranty claim, the owner of an Aqua Creek product must provide the place of purchase, in writing, with a full description of the product, its serial number, the dates of purchase and installation, and the exact nature of the defect. Within thirty (30) days after receipt of a written warranty claim by Aqua Creek, and barring any unforeseen delays, the place of purchase will be notified of Aqua Creek's decision regarding the claim.

If requested by Aqua Creek, any defective product must be returned, freight prepaid by customer, to Aqua Creek's designated factory location or duly appointed distributor for inspection and/or repair. Aqua Creek will, at its option, repair or replace the failed or defective item, and deliver the repaired product or replacement to the customer. All freight charges are the responsibility of the customer. Products returned to Aqua Creek for which Aqua Creek provides replacement under this limited warranty shall become the property of Aqua Creek. A new warranty period shall **NOT** be established for the repaired or replaced products. Such products shall remain under warranty only for the remainder of the original warranty period on the original products purchased.

This written limited warranty constitutes the final, complete and exclusive statement of warranty terms. No person or organization is authorized to make any other specific or implied warranties or representations on behalf of Aqua Creek.

THE WARRANTIES SET FORTH HEREIN ARE IN LIEU OF ALL OTHER WARRANTIES, EXPRESSED OR IMPLIED, WHICH ARE HEREBY DISCLAIMED AND EXCLUDED, INCLUDING WITHOUT LIMITATION ANY WARRANTY OF MERCHANTABILITY OR FITNESS FOR A PARTICULAR PURPOSE OR USE.

THE SOLE AND EXCLUSIVE REMEDIES FOR BREACH OF ANY AND ALL WARRANTIES WITH RESPECT TO THE PRODUCTS SHALL BE LIMITED TO REPAIR OR REPLACEMENT AT AQUA CREEK'S DESIGNATED FACTORY LOCATION, OR DULY APPOINTED DISTRIBUTOR, OR IN PLACE AT AQUA CREEK'S OPTION. IN NO EVENT SHALL AQUA CREEK'S LIABILITY EXCEED THE ENTIRE AMOUNT PAID TO AQUA CREEK BY THE ORIGINAL PURCHASER FOR THE FAILED OR DEFECTIVE PRODUCT.

IN NO EVENT SHALL AQUA CREEK PRODUCTS, LLC BE LIABLE FOR ANY INCIDENTAL, CONSEQUENTIAL, SPECIAL, INDIRECT, PUNITIVE OR EXEMPLARY DAMAGES OR LOST PROFITS FROM ANY BREACH OF THIS LIMITED WARRANTY OR OTHERWISE.

THIS WARRANTY GIVES YOU SPECIFIC LEGAL RIGHTS AND YOU MAY ALSO HAVE OTHER RIGHTS, WHICH MAY VARY FROM STATE TO STATE. SOME STATES DO NOT ALLOW THE EXCLUSION OR LIMITATION OF INCIDENTAL, SPECIAL OR CONSEQUENTIAL DAMAGES, SO SOME OF THE ABOVE LIMITATIONS OR EXCLUSIONS MAY NOT APPLY TO YOU.

Aqua Creek Products, LLC
9889 Garrymore Lane
Missoula, MT 59808
Toll Free: (888) 687-3552
Local/Intnl: (406) 549-0769
www.aquacreek.com